

Model NO.:V12

iNMOTION



Electric Unicycle **V12** User Manual

Inmotion Technologies Co., Ltd.
www.inmotionworld.com

Please read the user manual carefully. Don't ride this product before you fully understand the performance. And please keep the user manual.

***i*NMOTION**

Contents

1. About this manual	1
2. Product Overview	1
2.1. Serial Number	1
2.2. Packing list	1
2.3. Components	2
2.4. Features and Functions	2
2.5. Dimension	4
2.6. Specification	5
3. How to use	6
3.1. Preparation before ride	6
3.2. Install the App	6
3.3. How to ride	7
4. Care and maintenance	8
4.1. Storage	8
4.2. Battery maintenance	8
4.3. Inflate and replace the inner/outer tires	8
4.4. Cleaning and reminding	8
4.5. Safety instructions	9
4.6. Declaration of Hazardous Materials	10
4.7. FCC Statement	11
5. Legal Notices	11
5.1. Personal Information Statement	11
5.2. Intellectual Property Statement	12
Warranty	12

1. About this manual

This manual will be applied to INMOTION V12 Electric Unicycle from INMOTION Technologies Co.,Ltd. Fully understand all the warnings and precautions listed in this manual.

To obtain the latest info about the features/functions and safety guidance, please download the user manual in digital version from the official website. www.inmotionworld.com. Before you ride the electric unicycle, be sure that you have watched the tutorial video online if you are a beginner.

Standard of Product executivity:Q/LXTX 002-2017

2. Product Overview

V12 is an electric unicycle designed for urban commute, with 16 inch wheels, powerful motor, intelligent BMS, touch-screen, Automatic Headlight, high-quality speaker and other remarkable features and functions, for higher top-speed and more mileage (hereinafter referred to as V12 unicycle). Based on the principle of dynamic balance, the change of the unicycle's posture could be detected by the built-in gyroscope and acceleration sensor. Meanwhile with the servo control system, driver is able to make the below driving operations by leaning forward or backward, such as moving forward, acceleration, deceleration, braking and others.

2.1 Serial Number

The Serial number (hereinafter referred to as S/N) is the unique ID to each unit of the product, which could be used for the quality tracking, repair, insurance compensation, loss confirmation, etc. And the S/N is a 16-character number could be obtained from the following locations, such as package, the body of unicycle.

2.2 Packing list

Please double check all the components inside the package, and consult with your point of purchase if any parts lost

User Manual



Accessories



Charger

⚠ Warnings: Do not dis-assemble or modify the unicycle without permission from manufacturer, otherwise it may cause irreversible damage to the body of unicycle

2.3 Components

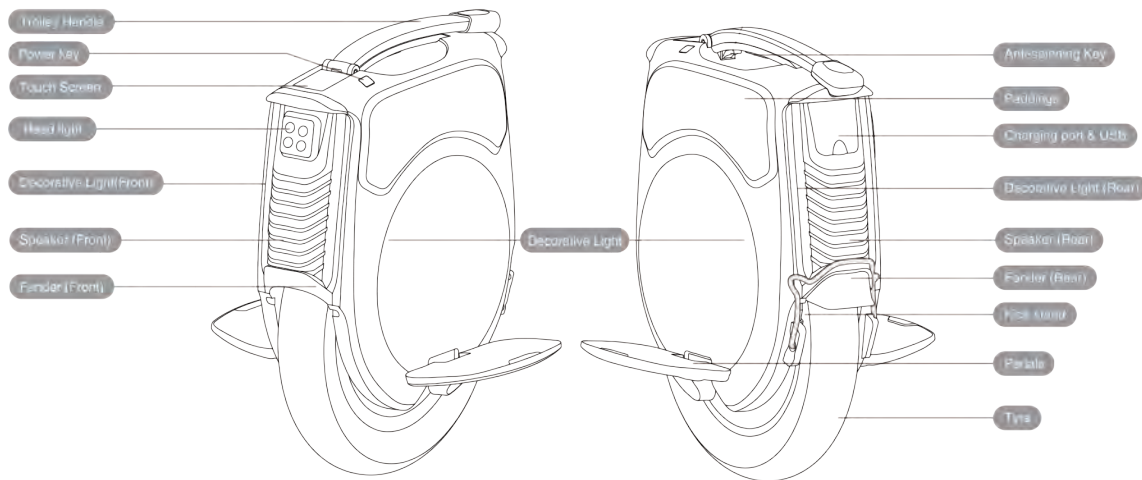

2.4. Features and Functions

- **Power on/off:** Long press the button to power on/off. User is allowed to set the access code for Touch Screen via Inmotion App.
- **Head-light:** Under the status of power on, one more click the button to light on/off. The head-light could be light off on Touch Screen or INMOTION App.
- **Tail-light:** Always on while riding, and blink when braking.
- **Anti-spinning button:** At the static status, the motor stops running when hold the Anti-spinning button.
- **Voice Prompt:** V12 provide the High-quality voice prompt while operating the vehicle or the vehicle works abnormally. On Inmotion App, user is allowed to customize the voice prompt, change the , Volume up/down, Switch on/off. If the voice prompt lost or with noise, please re-download via Inmotion App.

- **Charging:** The original charger is DC 100.8V/2.3A. The indicator of the charger is red/green, mean on-charging/charging completed. With two chargers working together, the charging time will be 50% cut off. The USB port could be used for power output.

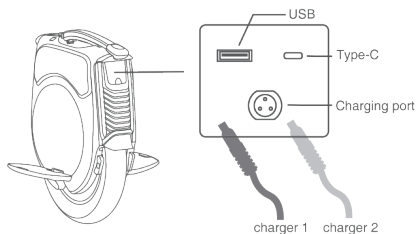

- **Trolley Handle:** Press the unlock button under the Trolley handle to unfold it; when the Trolley handle is not in use, hold the lock button under the Trolley handle to fold.

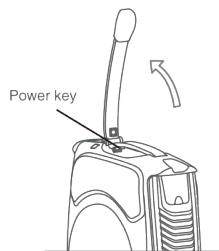

- **Kickstand:** Turn down the kickstand to park the unicycle.

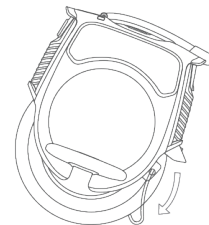

- **Touch-Screen:** Check real-time info of Vehicle on riding, set the parameters quickly.



- **Automatic Headlight:** Automatically adjust the lighting of head-light according to ambient light and speed
- **Audio System:** 4 set of high-quality speaker were assembly in the front/rear body of V12, and they could be connected with smart phone via bluetooth.
- **Decorative light:** 6 set of decorative LED strip were assembly on the left/right body of V12. Factory default lighting effect was provided, and user could DIY it as well.

2.5 Dimension

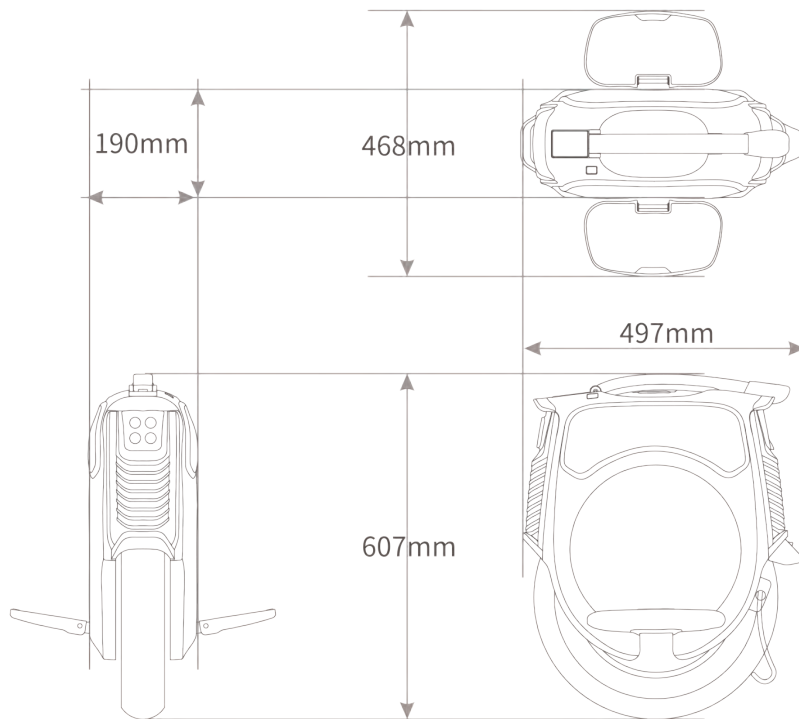

2.6. Specification

Specification		Parameter
Dimension	Dimension of Vehile	497*190*607mm
Payload & Weight	Max.Payload	120kg
	Net Weight	Approx. 29kg
Requirement of rider	Age	Over 16 years old
	Height	120~200cm
Performance	Max.Slope	35°
	Top Speed	70KM/H
	Classic Mileage	160KM
	Working Temp.	-10°C~+45°CV
	Storage Temp.	-20°C~+45°C
	IP Rating(Body)	IPX5
	IP Rating(Battery)	IPX7
Battery	Rating Voltage(VDC)	88.8V-
	Rating Power Capacity	1750Wh (875Whx2)
	Rating Power	Capacity Equalization/overcharge/ under-voltage overheat protection
Motor	Rating Voltage(VDC)	2500W
	Max.Power	5000W
Charger	Input Voltage	100~240VAC/50~60Hz
	Output Voltage	Approx. 100.8V -
	Output Current	Approx. 2.3A
	Certificate	CE,FCC,ETL
	Charging Time	Approx. 9h
Display	Touch Screen	

Typical Mileage: fully charged, 75kg payload, 25°C, no wind, and cruising at the flat road in 20km/h.

Max Slope Climbing Angle: fully charged, 75kg rider get the data through a large amount of tests.

Top Speed :fully charged, 25°C, no wind, and flat road.

3. How to use?

3.1 Preparation before using

The V12 is a personal electric transportation product. It may cause unpredictable injury and property damage if without knowing the operating guidance before riding. Below we will introduce how to ride V12 correctly and various precautions. Please read carefully and follow the guidance. Before riding, please double check and make sure all parts of V12 are not damaged and installed in place.

Before riding the unicycle V12, please make sure it had been continuously charged for more than 3 hours.

You need to find a relatively open and flat area for driving practice, at least 4m*4m, whatever indoors or outdoors. You need to fully understand the surrounding driving environment to ensure that you will not be disturbed by cars, pedestrians, pets, bicycles and other obstacles.

You need a skilled assistant around the side. The assistant needs to be proficient in operating the V12 and be familiar with all the precautions and driving methods in this manual.

Please do not test the vehicle on a slippery and wet ground.

Users are suggested to wear comfortable casual or sports clothing, and wear flat shoes, do a warm-up exercise to maintain flexibility.

Please be sure to wear a safety helmet and protective gear to avoid injury.

3.2. Install the App

Inmotion V11 unicycle supports Bluetooth 5.0 BLE, the BLE ID is: V11-XXXXXXX, where XXXXXXX is the last 8 digits of S/N.

Install Inmotion App on your mobile device (iOS 8.0 and above or Android 4.4 and above), and follow the prompts to connect your unicycle.

More functions in details, please check on the official website to download the manual of the latest version of Inmotion App.



Scan the QR Code to
Download Inmotion App

3.3 How to ride?

Before driving, please take all safety measures, such as: wearing sports clothes, helmets, knee pads, elbow pads and other protective tools.

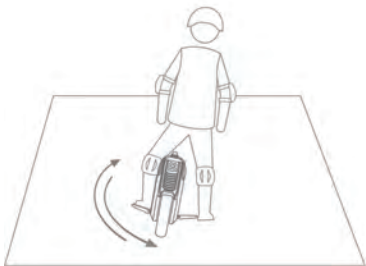

1. Put one foot on the pedal, glide forth and back.



2. One foot on pedal, keep your body upright, and gradually move up your center of gravity onto unicycle.



3. One foot on pedal, try put the other foot off the ground for 1-2 seconds.

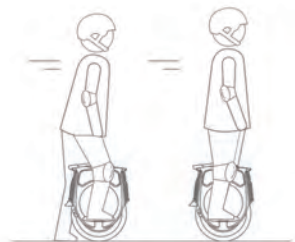

4. One foot on pedal, and the other foot pedals backward and glides.

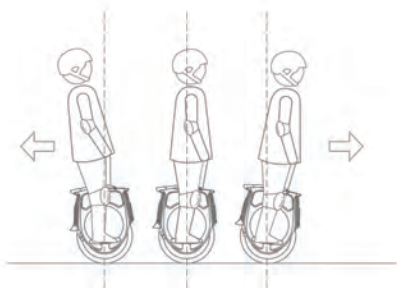

5. Put your feet on each pedals, control your center of gravity to move forward and backward.

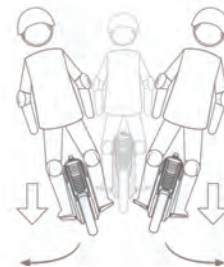

6. Press the pedals with feet by different force to make a turn.

4. Care and Maintenance

4.1 Storage

Please store the unicycle V12 in a dry and indoor location with, proper temperature and humidity. If you do not use unicycle for a long time, please recharge the battery at least once a month.

4.2 Battery Maintenance

- Do not put the battery at the environment with high temperature over 50°C or low temperature below -2°C (for example, do not put V11 or its battery in a car exposed under strong sunshine in summer). It's prohibited to throw the battery into fire, Otherwise which may lead to battery failure, overheating, even a risk of fire. For other maintenance precautions, please refer to the label on battery.
- Avoid the battery be exhausted completely before recharging. It's recommended to recharge before using, which could greatly extend the battery life.
- Under the regular temperature, the battery could perform a higher mileage; and under the environment below 0 ° C, the battery life and performance will decline.
- Typically, under the environment -20°C, the mileage may be only half or less than under the regular temperature. After the temperature rises, the mile range will be restored. For details, please refer to the remaining mileage displayed in the App.

Tips: The battery of V12 will be used up after about 120 to 180 days in standby status even it was fully charged. If the battery is not recharged in time, the battery may be damaged by over-discharged and this will be unrecoverable. There is a smart chip inside the battery to record the number of charging and discharging. The damage caused by long-term non-charging is not covered by warranty.

 Warning: Please use original charger only.

4.3 Inflate and replace the inner/outer tires

If the air pressure of V12 tires is insufficient, please inflate in time. The default value for unicycles is 2.8 Bar.

4.4 Cleaning and reminding

- Before cleaning, please make sure the unicycle be powered off, unplug the charging cable, and close the charging port. Keep the charging port be dry always.
- Wipe the outer case of V12 by a soft cloth with soapy water or clean water. It is forbidden to wash V12 by using a high-pressure water gun.

- The IP rating of V12 is IPx5, do not immerse the V12 into water, some permanent damage would be caused by this.

Tips: Do not clean the unicycle parts with alcohol, gasoline, medium oil or other corrosive and volatile chemical solvents, otherwise the appearance and internal structure might be seriously damaged.

4.5 Safety Instructions

For your safety and good driving experience, we suggest all users to strictly in accordance with the following requirements:

1. Please read carefully and fully understand the User Manual before driving.
2. Please do not allow people under the age of 16 to drive.
3. The pregnant women and persons with physical or psychological are forbidden to drive this unicycle.
4. Do not drive the unicycle while being sick or taking medicine or drinking, or if the physical or mental state is not good.
5. The unicycle is for single rider. Two or more persons are prohibited from driving on the unicycle at the same time, and it is not allowed to drive the unicycle with children on hold or carrying heavy goods.
6. Before driving, please make sure you have sufficient physical and mental conditions to get on/off from the unicycle and control it without assistance.
7. Do not modify or repair the unicycle without authorization .
8. Please make sure there is no any loose, damaged, faulty parts or other abnormal conditions before driving.
9. Before recharging the unicycle, please make sure the charging port be dry, trouble-free, and no foreign matter. Insert it into the correct charging socket, and avoid approaching by children and pets, and keep it away from flammable objects.
10. The battery of unicycle must be placed in an environment between -20°C and 45°C. Do not recharge and use it under the environment out of range -20°C ~ 45°C.
11. Please stop using it immediately and avoid any objects approach if the battery is deformed (including damage, odor, smoke or overheating).
12. It is forbidden to try to open or disassemble or do any abnormal operation to the battery.
13. Due to different battery conditions and environmental conditions, after fully charged (5 grids of remaining power displayed), the standby time of V12 is up to 180 days. While 1 grid remaining power displayed, the maximum standby time is 30 days. Please pay attention to the remaining power, to prevent irreversible damage to the battery caused by untimely recharging.
14. Do not wear inappropriate shoes or clothing to drive the unicycle, make sure to wear the professional protective gear on driving.
15. It's a must to wear protective glasses on driving to prevent the damage to your eyes caused by dirt, dust or insects in the air and the other possible adverse effects.
16. It is forbidden to driving the unicycle on heavy rainy weather and other inclined roads. The resistance to tires is reduced on the wet or slippery road, and the braking distance increased, the slip or accident may be easily caused by this, including loss of control

17. It is forbidden to drive the unicycle in bad weather, low visibility, poor light, and other adverse environments. Please do not drive the unicycle while you're extreme fatigue.
18. On driving, please pay attention to the changes in the road surface or surrounding environment in time, and avoid being harm to yourself or others.
19. Do not drive in unsuitable road conditions and environments such as stairs, elevators, or revolving doors.
20. On driving, please pay attention to the distance between the unicycle/your body and the obstacles.
21. Please do not take the risks when you encounter steep slopes, uneven road sections or other terrains that you have not encountered before.
22. Do not make a turning at the high speed, and do not brake suddenly on smoother roads. The dangerous situation (such as skidding) may easily be caused by these behaviors mentioned above.
23. It is forbidden to answer the phone or do any activities or behaviors that may distract you while driving the unicycle so that you can focus on monitoring the external environment at any time.
24. Unicycle is a personal transportation product for short-distance, and it is forbidden to use it to carry any goods or other improper purposes.
25. The data and parameters of the unicycle may be different according to the different models. please forgive that we may not inform the user if any change in parameters.

4.6. Declaration of Hazardous Materials

Spare Parts	Hazardous materials or element					
	Pb	Cd	Hg	Cr ⁶⁺	PBB	PBDE
Shell	O	O	O	O	O	O
Car Body	O	O	O	O	O	O
Battery Pack	O	O	O	O	O	O
Electric Machinery	O	O	O	O	O	O
Charger	O	O	O	O	O	O

This form is compiled in accordance with SJ/T 11364

O indicates that the content of the toxic and hazardous substance in all materials of the part is below the limit requirement of the SJ/T11363-2006 standard.

4.7 FCC STATEMENT

This device complies with Part 15 of the FCC Rules. Operation is subject to the following two conditions:

- (1) This device may not cause harmful interference, and
- (2) This device must accept any interference received, including interference that may cause undesired operation.

Warning: Changes or modifications not expressly approved by the party responsible for compliance could void the user's authority to operate the equipment.

NOTE: This equipment has been tested and found to comply with the limits for a Class B digital device, pursuant to Part 15 of the FCC Rules. These limits are designed to provide reasonable protection against harmful interference in a residential installation. This equipment generates uses and can radiate radio frequency energy and, if not installed and used in accordance with the instructions, may cause harmful interference to radio communications. However, there is no guarantee that interference will not occur in a particular installation. If this equipment does cause harmful interference to radio or television reception, which can be determined by turning the equipment off and on, the user is encouraged to try to correct the interference by one or more of the following measures:

Reorient or relocate the receiving antenna.

Increase the separation between the equipment and receiver.

Connect the equipment into an outlet on a circuit different from that to which the receiver is connected.

Consult the dealer or an experienced radio/TV technician for help.

5. Legal Notices

5.1 Personal Information Statement

1. The personal information includes what you voluntarily entered when you connected to the unicycle with Inmotion App (hereinafter referred to as APP) to bind the devices and you're voluntarily provided during using the product. Personal information, including but not limited to your name, gender, age, address, contact information, occupation, and time and place of using our services.
2. While using the APP, your personal information provided on the procedure of owner verification, product serial number activation, questionnaire, after-sale tracking, events to collect the suggestions to the related products or services, will be helpful to us to provide you with better products and services and improve your user experience.
3. You reserve the right not to provide personal information, however, this may let us be unable to provide you with better product functions and services, or even affect your use of our products and services.
4. Under any of the following conditions, you agree that we may provide your personal information to relevant third parties:
 - (1) After your special authorization;
 - (2) Comply with the mandatory requirements of the relevant laws or government agencies (including judicial agencies);

- (3) Enforce available service terms (including investigation of possible violations);
 - (4) For the purpose to deal with fraud, security or technical issues;
 - (5) To protect the rights, property or safety of users or the public from damage to the extent required or permitted by law;
 - (6) In special and/or emergency situations.
5. The use, transmission, and storage of your personal information include electronic data, and the aforementioned behavior may be located within or outside China.
6. For your better user experience, you fully agree that Inmotion and its affiliates may occasionally push information about products and services to you.
7. For the security of your personal information, we will take reasonable and safe measures to protect it from unauthorized disclosure and use.
8. And you agree that Inmotion will decide how long to store and retain your personal information according to the time required for the specified purpose or any agreement, laws, and regulations. For warranty policy, please consult with the point of purchase or email to the manufacturer's service team: service@imscv.com.
- Again, we appreciate your purchasing of Inmotion products.
9. You agree to waive all claims, liabilities, and losses caused or probably to be caused by the disclosure or use of your personal information in accordance with this legal statement by receivers and/or users such as Inmotion and/or affiliates. Claims, liabilities and losses are caused by the direct intentional acts or gross negligence of the recipient and/or user.

5.2 Intellectual Property Statement

- 1. Unless otherwise stipulated by laws and regulations, or otherwise stipulated in the agreement, Inmotion has intellectual property rights (including but not limited to the copyright, trademark rights, patent rights, and their application rights, implementation rights related to products and their accessories, APPs, and websites, Permission, etc.) All rights are reserved. Without the prior written consent of Inmotion, no illegal use or any other punishment shall be allowed.
- 2. This legal statement applies to the laws of the People's Republic of China.
- 3. For all claims, responsibilities, and losses caused by consumers or any third party in violation of this legal statement, Inmotion shall not be liable for any compensation.
- 4. This legal statement constitutes an inseparable statutory part of Inmotion products.
- 5. You can choose to accept all the terms of this legal statement and use Inmotion products. If you use Inmotion products, you are deemed to agree to accept all the terms of this legal statement and bear any possible risks and responsibilities.

6.Warranty

For warranty policy, please consult with the point of purchase or email to the manufacturer's service team: service@imscv.com.
Again, we appreciate your purchasing of Inmotion products.



Scan the QR Code to
Download Inmotion App



Scan the QR Code to Join
INMOTION Escooter Facebook
Group