



KS-X1 PRO

User

Manual

Cautions

Electric scooter is a recreational personal transporter. Before mastering riding skills, you need to do practice. You will be responsible for any injuries or damage caused by a rider's inexperience or failure to follow the instructions in this manual.

Please understand that you can reduce the risk by following all the instructions or warnings in this manual, but you cannot eliminate all the risks.

Please following the local traffic laws or restrictions when riding into public areas.

Please always wear a helmet properly when riding to protect your head, as well as other necessary protectors, such as elbow pads, kneecap.

Please slow down the riding speed when riding on crossing, going across the crowd, making a turn, climbing or downing a hill, passing a school and other place that high speed may bring damage to people.

Please do not allow kids of age below 12 to use the scooter on public area. Riders under the age of 18 years old should ride under adult supervision.

Please do not use the scooter in serious environments, to avoid scooter

malfunction, which may cause damage to body or property, such as Rainy, Snowfield, Grassland, Miriness, Fog, Smoke and so on.

Please do not use the other chargers to charge E-scooter, Only use King Song supplied charger.

Please do not charge E-scooter, if the charger or power outlet is wet.

Please do not disassemble the scooter body or other modify without professional person from distributors.

Please do not allow others to ride your e-scooter unless he/her has carefully read and follow the instructions in this manual.

Contents

1. Product Details-----	01
2. Features -----	04
3. Button Usage -----	05
4. Assembly and Set-up-----	06
5. APP Usage -----	07
6. Folding and Carrying-----	17
7. Adjusting the disc brake-----	18
8. Adjust the handlebar-----	19
9. Battery -----	19
10. Clean and Maintenance-----	20
11. Warranty-----	22

1. The Device & Accessories

1.1 Diagram: KS-X1 PRO



Accessories



Screws



Hex Wrench



Valve Stem Extension



Charging Adapter

1.2 Functions

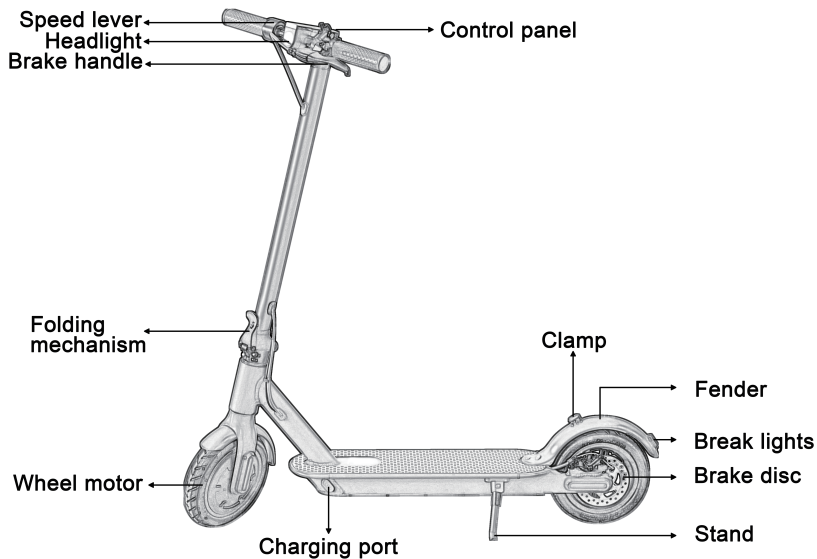

1.3 Specifications

Model No	KS-X1 PRO
Size	8.5 inch Inflatable Tyre
Top Speed	30 km/h
Mileage	Around 45km
Gradeability	Around 20°
Battery Capacity	37V, 12.8Ah
Running Condition	-10 ℃/+80 ℃ ; 0-90% Humidity
Storage Condition	-10 ℃/+50 ℃ ; 0-90% Humidity
Max Load	125kg
Charger	Input: 100-240V; Output: 42V/2A
Charging Time	Around 6hrs.
Motor	500W
Port	Charge Port *1
Headlight	4W
Brake Light	LED
Applicable Height	1200-2000mm

Parking Mode	Kick-stand
Cruise Control	System control
Reminder	Mechanical Bell
Accelerator	Throttle Button
Brake	EABS+Rear Disc Brake
Display	LED
Battery Display	5 Bars in monitor
Dimension(Unfold)	1130*430*1190mm
Dimension(Folded)	1130*430*480mm
Net Weight	14kg
Packing List(pcs)	User Manual*1, Certificate*1, Charger*1, Screws *4, Hex Wrench*1, Valve Stem Extension*1

2. Features

- Superior Aviation Aluminum Alloy.
- Real-time Temperature Monitoring, Short Circuit / Low Voltage / Overcurrent / Overcharging Protection.

- Digital Speedometer Display, Easy to Read Speed.
- Real-time 5 Bars Battery Display.
- 1~3 Speed Gear, Press Button to Switch.
- Malfunction Display.

3. Button Usage

- Power ON/OFF: Long press the button for 3 seconds, all icons are lighting, showing speed & battery.

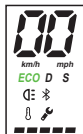

- Headlight ON/OFF: Click the button (Headlight ON: ☾☽)



- Click the button for two times to change the speed gear from 1 to 3 levels, LED display ECO / D / S. Max speed is increasing when LED display from ECO to S.



4. Assembly and Set-up

1. Fasten the handlebar stem on the headset, and put the kickstand down
2. Attach the handlebar to the stem

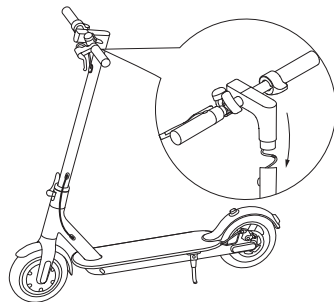
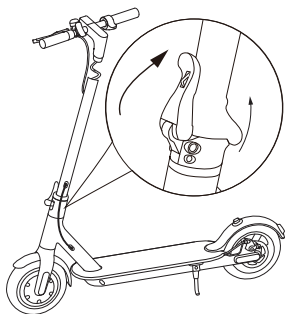

3. Tighten the screws onto both sides of the stem with the hexagon wrench

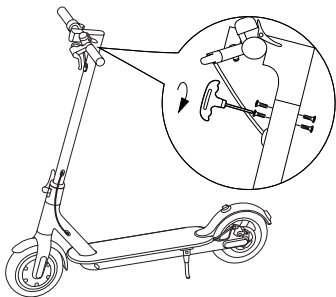

4. After the assembly, press the power button to check if it's working properly

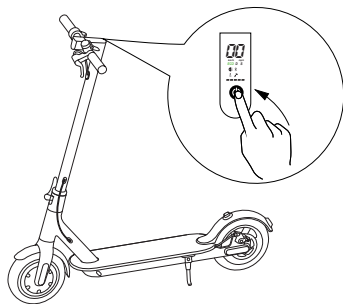

5. APP Usage

5.1 First Ride

Mobile device Requirement:

iOS 10.0 or above,

Bluetooth 4.0 or above.

Install the APP and register/login.

Android 4.3 or above,

Install the APP and register/login.



iOS



Android



Please give the corresponding permission to scooter APP, to ensure the APP can run normally in your mobile device.

Open Bluetooth/location (or GPS), Click 'Search' -> Click the corresponding model KS-X1 PRO in device list to connect. The E-scooter will beep when APP is connected with E-scooter.

5.2 Learn to Ride

- Step 1: Check E-scooter Status

Check the environment whether it's safe to ride without hurting yourself or others.

Check the battery level and remain mileage in APP.

- Step 2: Wear protective equipment.

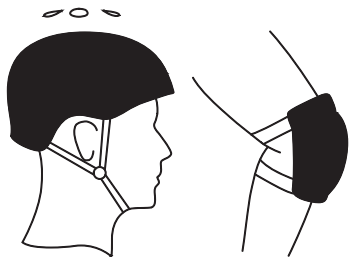

- Step 3: Try to slide with one leg.



- Step 4: Touch the throttle slightly and try to put two legs on the deck.

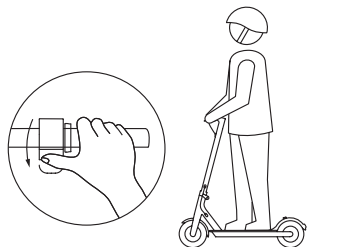

- Step 5: During riding, try to release the throttle and pull the brake lever.

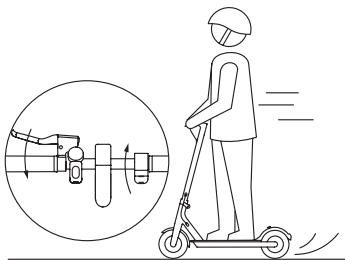

- Step 6: Try to use the headlight.



5.3 Warnings

- Wear protective equipment.
- Do not ride in rainy or cross puddles.

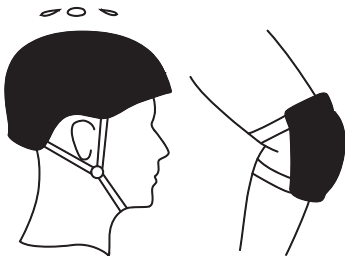

- Do not load over 125kg.

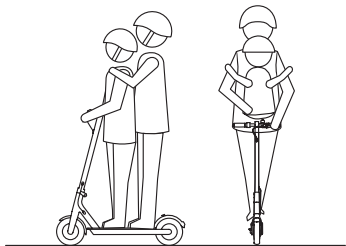

- Ride slowly in special cases.

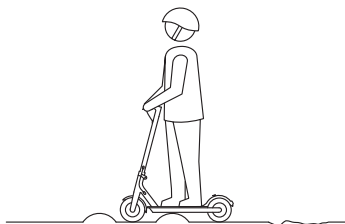

- Do not place one foot on the deck or on the ground when riding.



- Do not tread the back of the fender.



- Do not touch the disc brake

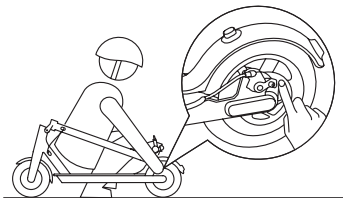

- Do not leave your hands during riding.



- Do not ride upstairs or downstairs, or over obstacles.

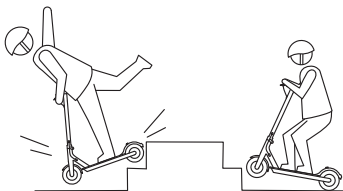

- Do not hold a child during riding.

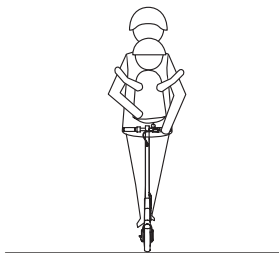

- Do not ride on highway or motor vehicle road.
- Do not ride with sharp turn.

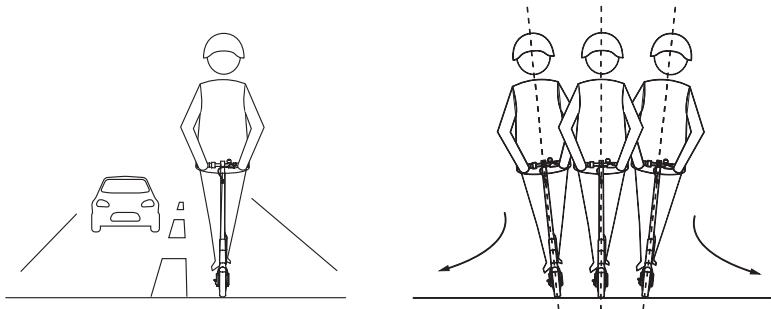

5.4 Cruise Control

Open cruise-control in APP, while you keep the same speed, riding for 3~5 seconds, the E-scooter will be in cruise-control mode (running at constant speed on flat road) Please use cruise-control only on flat road, or you will fall down on other roads.

5.5 Error Description

Display	Defect Description	Solutions
E0	Wrong in communication	<ol style="list-style-type: none">1. Check whether the display control board is well connected;2. Replace the display.3. Replace the control board.
E1	Encounter obstacles that E-scooter can't get over it	<ol style="list-style-type: none">1. Release the accelerator and stop braking.2. Restart.3. Replace the brake lever.4. Replace the accelerator.
E3	Hall is abnormal	<ol style="list-style-type: none">1. Check whether the Hall wire plug of the motor is loose.2. Check whether the motor cable is damaged.3. Replace the motor.4. Replace the control board.
E4	Brake system malfunction	<ol style="list-style-type: none">1. Release the brake.2. Restart.3. Replace the brake lever.
E5	Throttle fault	<ol style="list-style-type: none">1. Release the accelerator.2. Restart.3. Replace the accelerator.

BL	Low voltage alarm	<ol style="list-style-type: none"> 1. Stop riding and get scooter charged. 2. Restart. 3. Check if firmware has been wrongly upgraded. 4. Replace the control board.
BH	High voltage alarm	<ol style="list-style-type: none"> 1. Check whether scooter has been fully charged, riding the scooter at low speed, avoiding braking suddenly when scooter is fully charged. 2. Restart. 3. Check if firmware has been wrongly upgraded. 4. Replace the control board.
BP	Over voltage, emergency	<ol style="list-style-type: none"> 1. Check whether scooter has been fully charged, riding the scooter at low speed, avoiding braking suddenly when scooter is fully charged. 2. Restart. Check if firmware has been wrongly upgraded. 3. Replace the control board.
H1	Motor high temperature	<ol style="list-style-type: none"> 1. Stop riding or riding scooter at low speed, avoiding climbing.

		<ol style="list-style-type: none"> 2. Check whether the motor wire is damaged, and whether the temperature signal wire of the motor wire is short-circuited to the ground. 3. Replace the motor.
H2	Control board high temperature	<ol style="list-style-type: none"> 1. Stop riding or riding scooter at low speed, avoiding climbing. 2. Check the installation of control board radiator. 3. Replace the control board.
H3	Control board super high temperature	<ol style="list-style-type: none"> 1. Stop riding or riding scooter at low speed, avoiding climbing. 2. Check the installation of control board radiator. 3. Replace the control board.
LR	Over current	<ol style="list-style-type: none"> 1. Release the accelerator. 2. Restart. 3. Replace the control board.
S1	Short circuit	<ol style="list-style-type: none"> 1. Get the motor disconnected and restart up scooter. If this alarm has not been cleared, get control board replaced; otherwise, all-clear, replace the motor.

S2	Lack of phase, mos tube drive failure	<ol style="list-style-type: none"> 1. Restart and turn scooter on as static, avoiding turning on scooter while advancing. 2. Replace the control board.
SN	Lack of series number	<ol style="list-style-type: none"> 1. Check whether the firmware version is correct. 2. Reset the serial number.

6. Folding and Carrying

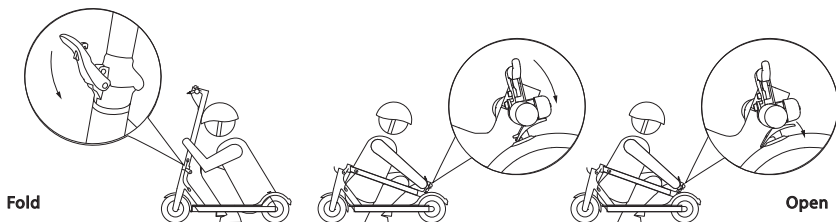

Make sure that the scooter's turned off. To fold, unlock the folding mechanism, and bend the handlebar stem to hook the buckle on the rear mudguard. To open, press the bell trigger to remove from the buckle, erect the handlebar and lock the folding structure.

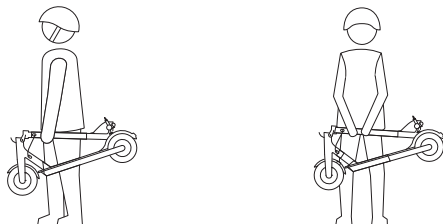

Carry

Hold the handlebar stem with either one hand or both hands to carry.

7. Adjusting the disc brake

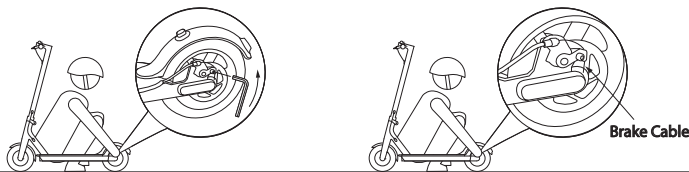

If the brake is too tight, use the hexagon wrench to loosen the screws on the caliper, and slightly send back the brake cable to shorten the exposed length, then tighten the screws. If the brake is too loose, loosen the screws, and slightly pull out the brake cable to lengthen the exposed length, then tighten the screws.

8. Adjust the handlebar

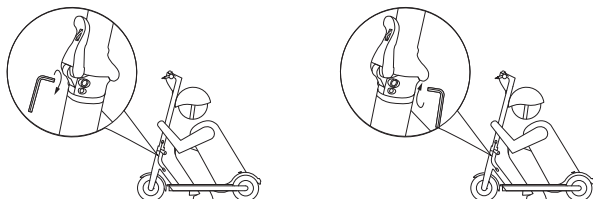

If the handlebar and its stem sway during riding, use the hexagon wrench to tighten the screws on the folding mechanism.

9. Battery

9.1 Temperature Effect on Battery

Battery power will vary with the temperature, mileage per charge will have slight difference under different temperature, and following table is just for your reference.

Temperature(°C)	-20	-10	0	10	20	30	40	50
174Wh using ratio	40%	60%	80%	90%	95%	100%	105%	110%
MPC(Km)	8	12	16	18	19	20	21	22

MPC: Mileage per fully charged.

9.2 Charging

The device has a built-in lithium battery, no extra battery installation is required, just charge the device when it indicates low battery.

Plug in the power source after inserting the charger plug, this can prevent potential risk to ensure a safer charger.

It takes around 6hrs to get 100% charged, when the red lights turn into green, indicating the charging is completed.

If not in urgent need, please wait until charging complete before unplugging, for after charging, the protection circuit will perform flow equilibrium.

10. Clean and Maintenance

10.1 Clean and Maintenance

When charging

- Please place the E-scooter in cool and ventilate places to release heat.
- Please avoid high temperature or moist.
- Please avoid water into the E-scooter to prevent electric shock, especially water drops from the charger cable to the the charging port.

When cleaning

- Please make sure the E-scooter is off.

- Please use soft cloth to clean the E-scooter.
- Please don't use water to wash the E-scooter or place E-scooter in water.

When storage

- Please place the E-scooter in cool and ventilate places (temperature -10~50 ℃, relative humidity 0~90%).
- Please don't place subjects on the E-scooter or heavy subjects to squeeze the E-scooter.

10.2 Battery Pack Maintenance

When the E-scooter is fully charged, please check the voltage of the battery in APP. Normal voltage is 31V~42V.

If the voltage is not in this range, please contact the distributor for battery pack maintenance.

Please charge the E-scooter at least one time each month, to extend the battery pack lift time.

Please do not disassemble, assemble or change the battery by yourself.

10.3 Regular Maintenance

Please do not disassemble or assemble the E-scooter without the guide or help from professional maintenance from the seller or distributors.

Please make a video or photo to distributors when the

E-scooter run abnormally, as well as providing the serial number.

11. Warranty

11.1 Limited Warranty

Sellers warrant the EUC by following limits.

Motor, Controller board for 365 days from the item departure from factory.

Battery package for 183 days from the item departure from factory.

11.2 Exclusion from Warranty

Above limited warranty DOES not include damage or loss not caused item's defectives (i.e. warranty only covers manufacturer defectives, does not cover any damage, unauthorized modification, improper operation, disassembly etc.)

11.3 After Sale Service

Please contact the local sellers or distributors for after-sale service.

Kingsong Intell Co.,LTD

Address : BLDG 7, NO 71 XINGHU RD, 8TH INDUSTRY PARK,
HONGXING, YUTANG, GUANGMING, SHENZHEN

Tel : +86-755-23193477

Fax : +86-755-23193248

E-mail : info@szkingsong.com