

**NEWLY 3D PRINTER WITH UPGRADED
CHIP AND CONVENIENT FUNCTION**

CR20

Focus more on the quality
More simple but exquisite

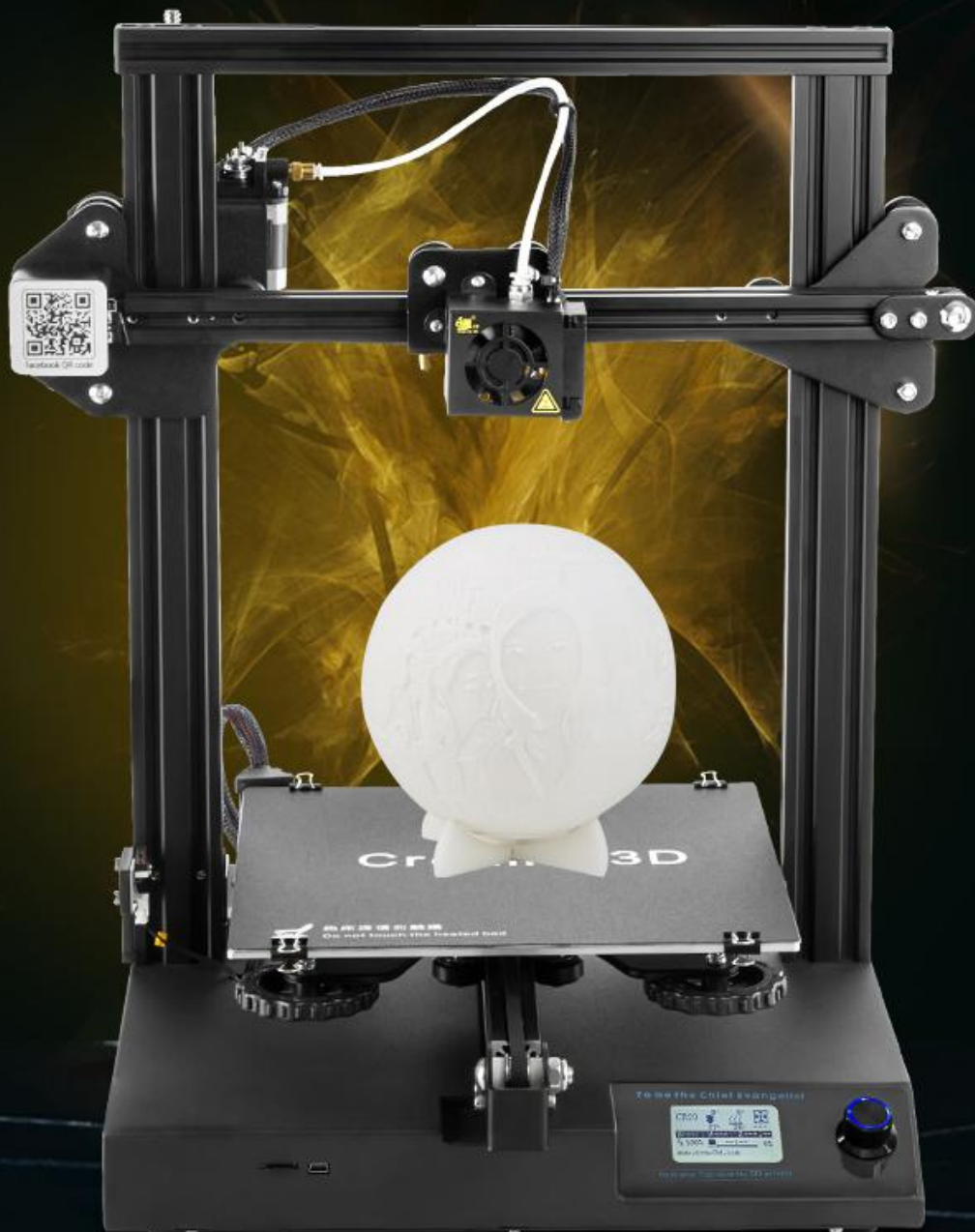

Integrated
one-piece
appearance

Humanized
design

High-quality
hardware

Highly
integrated
module

Patented
technology

Quick remove
self-adhesive
platform



PRODUCT PARAMETERS

| | |
|-------------------------|---------------------|
| Forming size | 220*220*250mm |
| Platform size | 235*235mm |
| Power | 24v 270W |
| Power failure detection | Standard |
| Max nozzle temperature | 260°C |
| Max hot bed temperature | 100°C |
| Machine net weight | 7.5KG |
| Package weight | 9.5KG |
| Machine size | 420*410*470mm |
| Package size | 475*460*270mm |
| Power parameters | 110/220V AC 50/60HZ |

SIX ADVANTAGES

1

Integrated modular design , simple but generous.



2

2 screws for quick installation

Two modules, just needs six screws and can be quickly installed

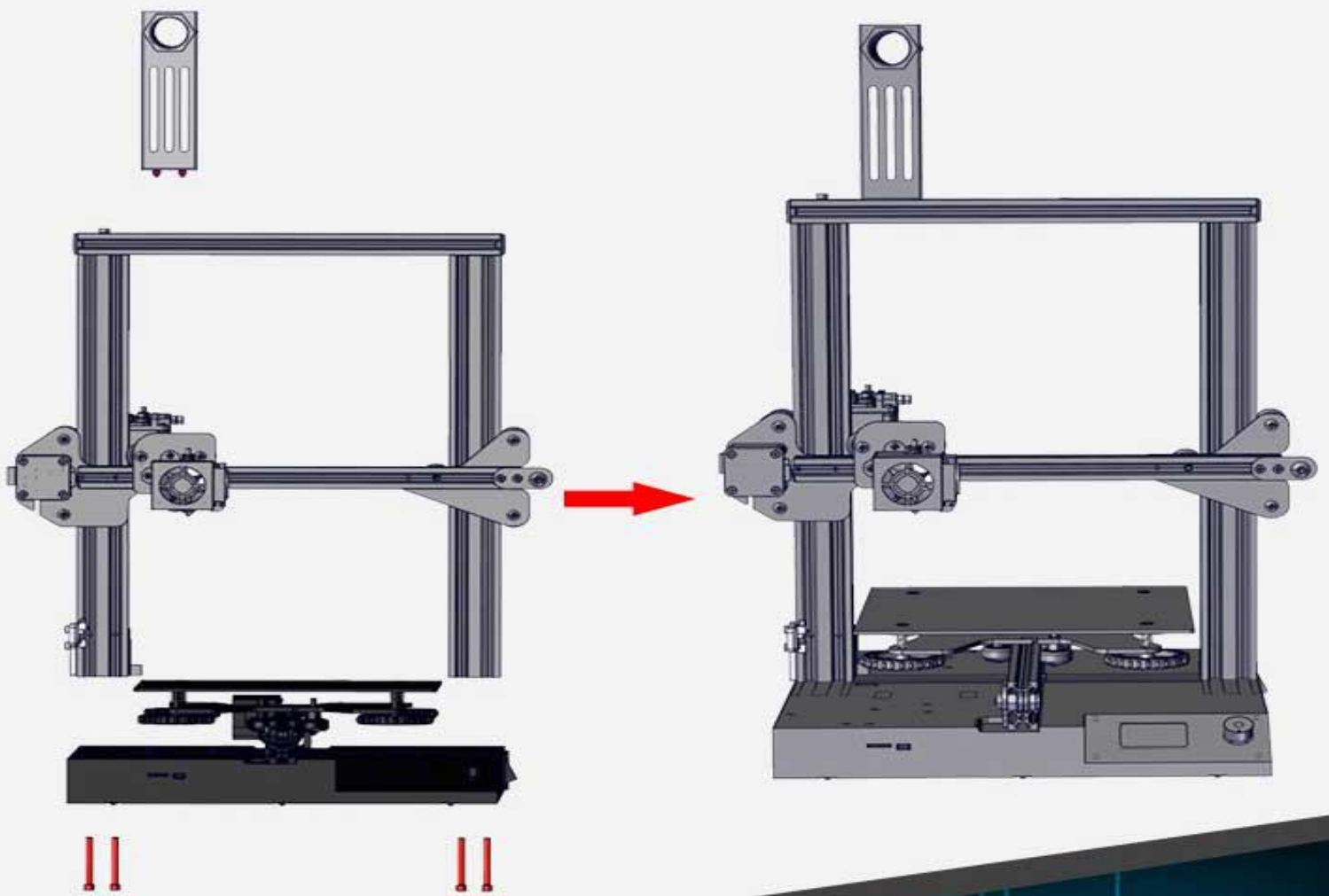

Creality3d V2.1 main board
Stable Printing speed

3





∠30° tilt display



∠30° tilt display
Humanized design,
more convenient operation.

Self-adhesive platform,
more convenient to take the model



No blade,
easy removal of model

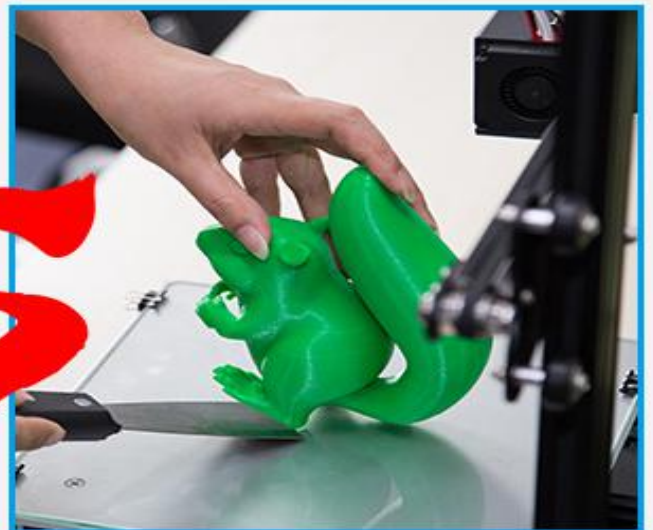

Need to use a blade
to take the model



Resume print after powering-off

Add the power failure continued function to make sure the model can be printed normally.



Print before the power-off



Finish printing

MACHINE DETAILS

High technology High quality
accessories highlight quality



Rigid Couplings



Mold large nut



Brass nozzle



Long extrusion clamp



High quality power supply

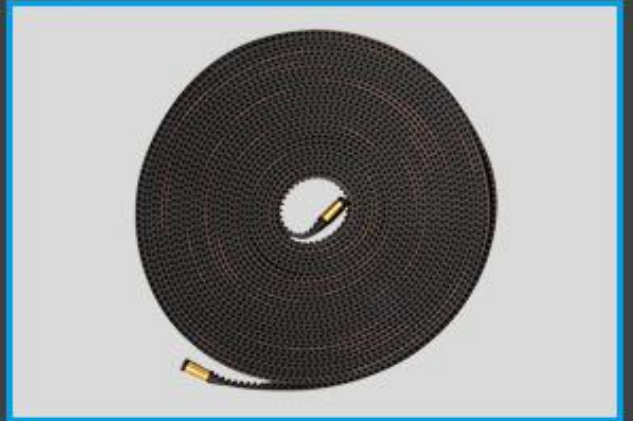

High quality timing belt

MACHINE PACKING

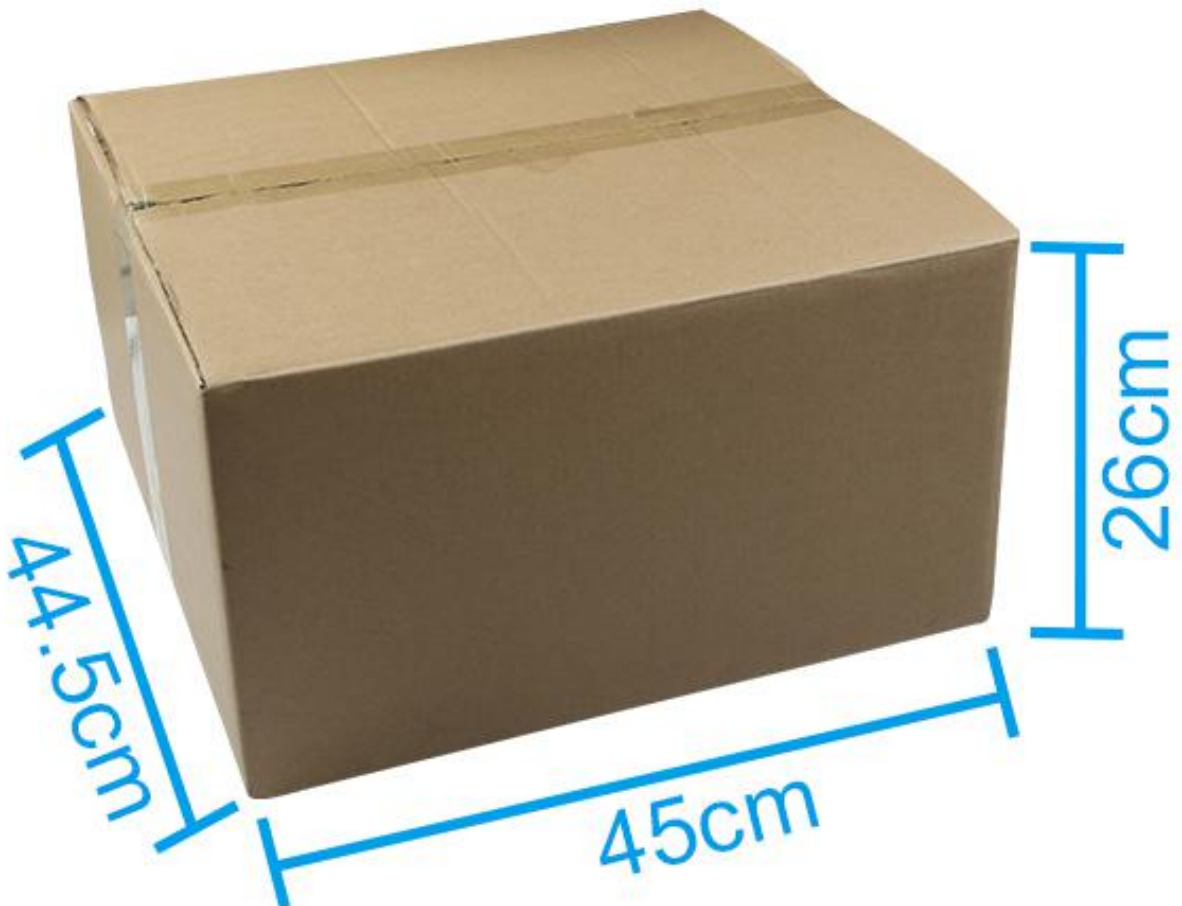

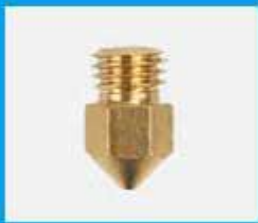

PRINT MODEL DISPLAY

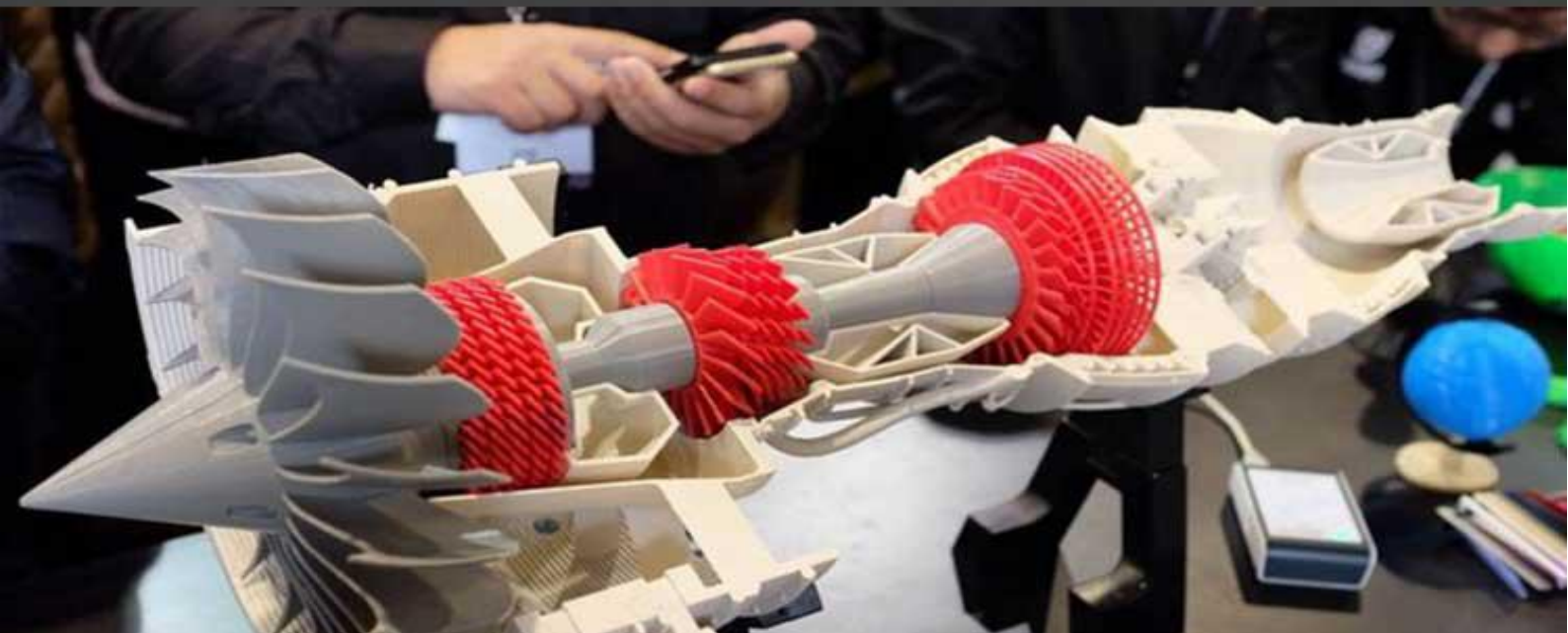
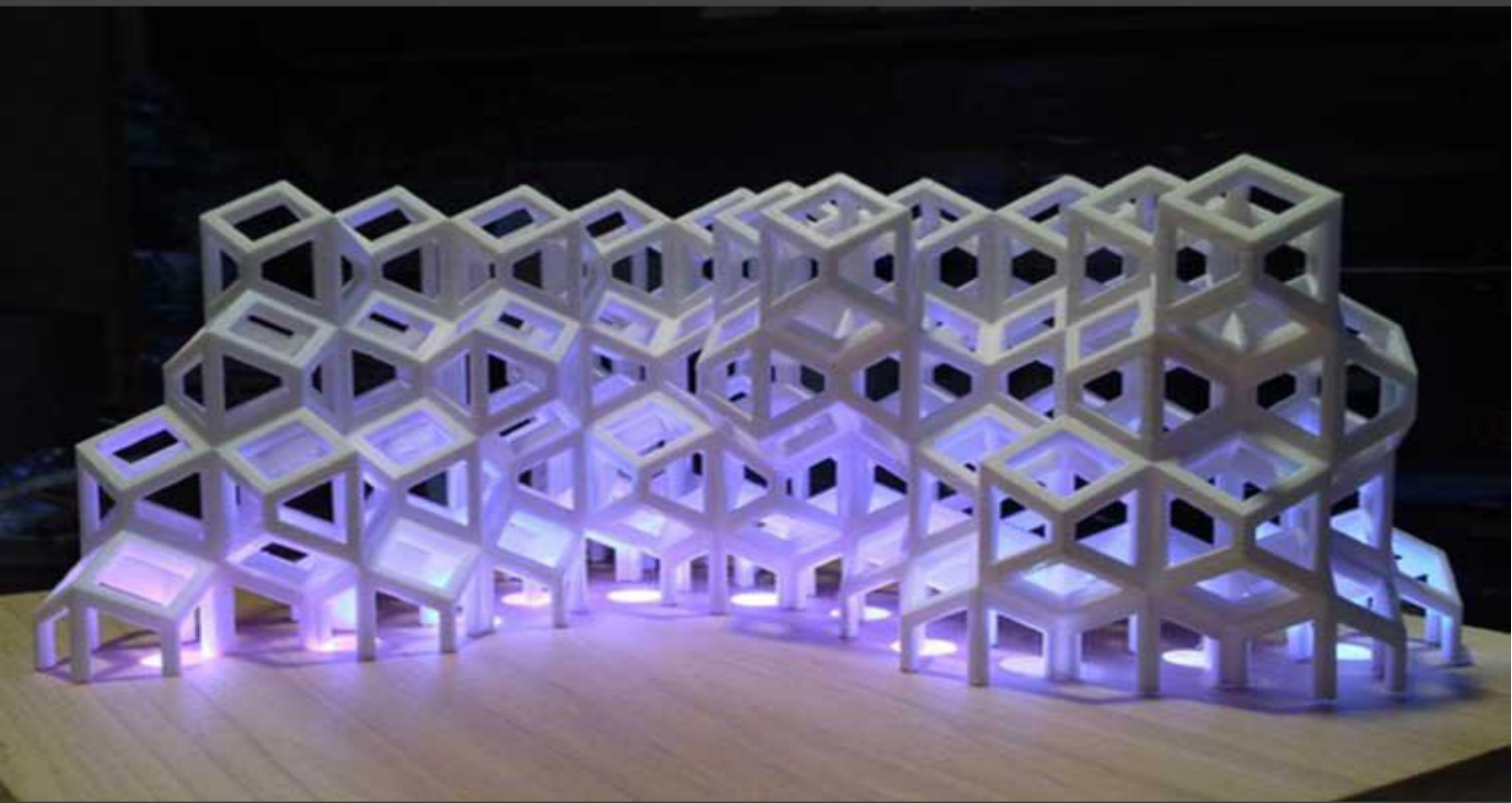



**Only once formed,
by the post-coloring**

Statue

Printing parameters

printing layer: 0.1mm

printing speed: 60mm/s

printing size: 162*45*312mm

Once formed, with smooth surface



Gear model

Printing parameters

printing layer: 0.1mm
printing speed: 60mm/s
printing size: 100*100*60mm



Bird cage model

Printing parameters

printing accuracy: 0.1mm
printing layer: 0.1mm
printing speed: 60mm/s
printing size: 140*140*300 mm

SHENZHEN CREALITY 3D TECHNOLOGY CO.,LTD.
3DPRINTER EVANGELIST

EXCELLENT 3D PRINT EVANGELISTS

A group of young people who fought for creality

KEEP IMPROVING FOR MORE PRECISE KEEP IMPROVING FOR MORE PRECISE KEEP IMPROVING FOR MORE PRECISE KEEP IMPROVING FOR MORE PRECISE KEEP IMPROVING FOR MORE PRECISE
KEEP IMPROVING FOR MORE PRECISE KEEP IMPROVING FOR MORE PRECISE KEEP IMPROVING FOR MORE PRECISE KEEP IMPROVING FOR MORE PRECISE
KEEP IMPROVING FOR MORE PRECISE KEEP IMPROVING FOR MORE PRECISE
KEEP IMPROVING FOR MORE PRECISE
KEEP IMPROVING FOR MORE PRECISE

COMPANY ADVANTAGE



More dreams, More Creality



Company Profile

Shenzhen Creality 3D Technology Co., Ltd, founded in June 2014, is a high-tech enterprise specializing in the production and sales of 3D printers, owns two series of DIY and complete machines, totaling more than 20 products, fully meeting the needs of different users such as individuals, families, schools, and companies. The entire series of products and their engineering development processes have independent intellectual property technology and dozens of patents. The products have passed many international quality and environmental certifications such as CE, FCC, and ROHS, and are exported to Europe, the United States, Australia, Russia, and the United Kingdom. , Germany, Singapore, Egypt, India and more than 30 countries.

Honor

